

Product features

- Built-in non isolated adjustable power LED driver
- Flicker free LED driver
- Output current 200 mA...350 mA
- Max. output power 42 W
- For illuminates of protection class I
- DC emergency
- Current output default value 200 mA
- 5-year warranty



Product specifications

163557 XZ-LH40B-121035-A

Output current	Input voltage	Output voltage	Efficiency @full load	Current accuracy	Power factor	Dimension LxWxH (mm)
200...350 mA	220...240 Vac 220...240 Vdc	52...120 Vdc	93% (@ 120 V 0.35 A)	± 5%	0.8 C-0.95 (@ 230 Vac 50 Hz)	137×30×21

Electrical specifications

Mains voltage supply

Rated input voltage range	220...240 Vac
Max. input voltage range	198...264 Vac
Rated frequency range	0/50/60 Hz
Max. input current	0.21 A @ 230 Vac & 0.21 A @ 230 Vdc

Battery operation

DC voltage range	220...240 Vdc
Max. DC voltage range	176...280 Vdc

Protection against voltage peaks

Withstand voltage	I/p-GND: 1.5 KVac, < 5 mA 60 sec; O/p-GND: 1.5 KVac, < 5 mA 60 sec;
Mains surge immunity	L-N 1 KV; L-GND: 2 KV; N-GND: 2 KV;

Total harmonic distortion (THD)

At rated input voltage range @ full load	20%
--	-----

Output data

Output current tolerance	± 5% at rated input voltage range
No load output voltage	160 Vdc
Ripple output current	5% (ripple = peak/average total 100 Hz)
Output PstLM	≤ 1 at full load @ rated input voltage
Output SVM	≤ 0.4 at full load @ rated input voltage

Protection functions output side

Overvoltage protection	The output voltage is less than or equal to 120 V
Short circuit protection	Hiccup mode. Protection device will trigger when short circuit and will auto recover after the fault mode is removed.

Dimming operation and interface

Standby power consumption	-
---------------------------	---

Connection terminals

Connection terminal type	45° push in terminal
Wire cross section	Input wire: 0.5...1.5mm ² ; output wire: 0.2...1.5 mm ²
Wire stripping length	8...9 mm

Degree of protection

Protection rating	IP20
-------------------	------

Operating data

Output current range	Output current 200...350 mA by DIP Switch adjust
Default current	200 mA
Output voltage range	52...120 Vdc

Circuit breaker / Inrush current

MCB loading quantity	Inrush current I _{peak} : 17.7 A			Inrush current T _{width} : 224 μs	
	MCB type	B10	C10	B16	C16
	Units	18	29	28	47

Supplementary instructions

- The luminaire manufacturer is responsible for measuring and verifying the EMI compliance of the complete luminaire, as the level of radio interference will vary depending on the luminaire construction. Especially primary and secondary cable lengths and their routing may have a significant effect on radio interference.
- For the push DIM function, please follow our instructions, which can be downloaded from www.cupower.com.
- The recommended NFC communication distance: 5...20 mm.

Environmental specifications

Operating temperature	-20...+50°C
Storage temperature	-40...+80°C
Working humidity	10%...90%
Store humidity	5%...90%
Lifetime	at Tc ≤ 65°C: 100000 hrs, at Tc ≤ 75°C: 50000 hrs; at Tc ≤ 80°C: 35000 hrs
Maximum Tc temperature	80°C

Safety & EMC compliance

ENEC+CE	CCC	SAA
EN 61347-1:2015/A1		AS 61347.2.13
EN 61347-2-13:2014/A1		AS/NZS 61347.1: 2016+A1
EN 62384		
EN 61347-1:2015/A1		
EN 61347-2-13:2014/A1		

Dimensions

Housing dimensions

Length (L)	137 mm
Width (W)	30 mm
Height (H)	21 mm
Weight	0.0881 kg

Packaging details

Packing units	60 pcs
Carton size	317 × 147 × 160 mm
Weight	5.5 kg

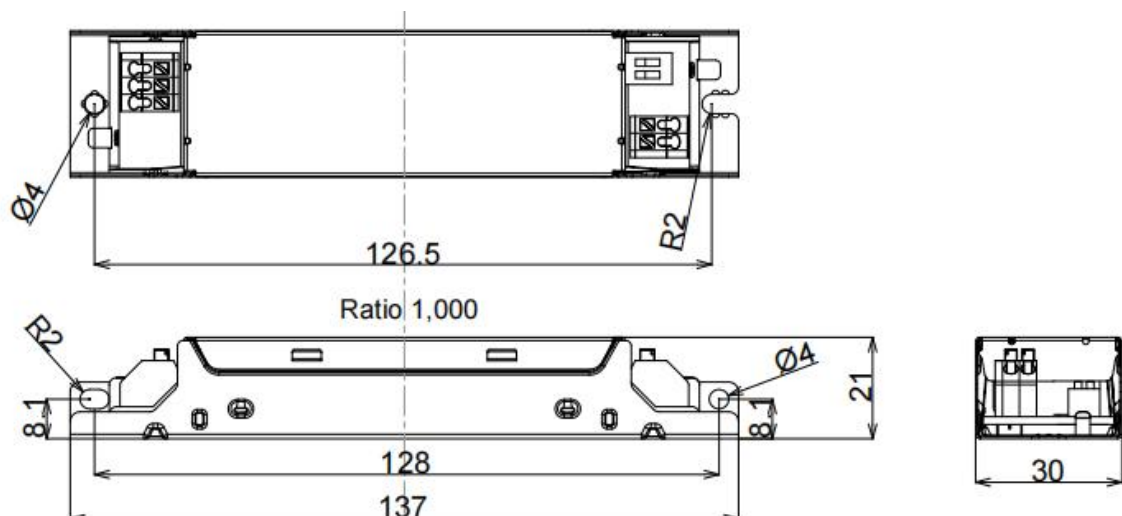

Wiring diagram

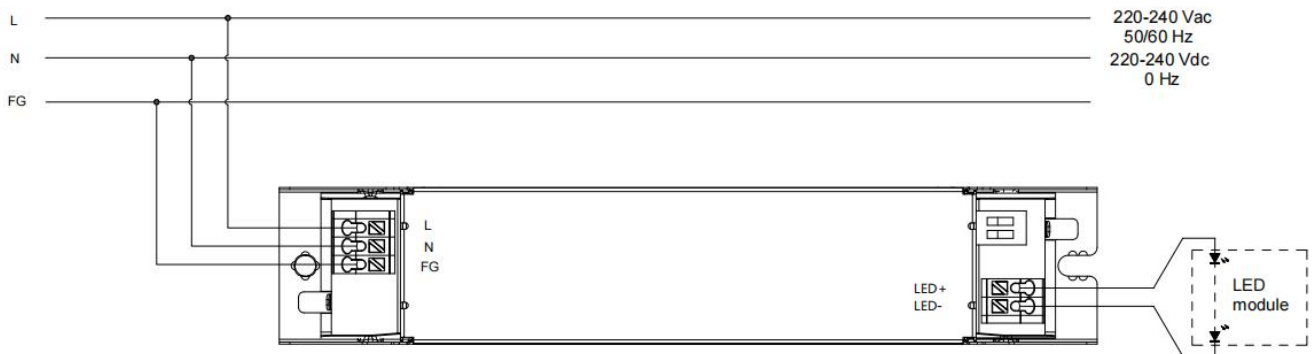

- All connections must be as short as possible to ensure good EMI performance.
- The luminaire wire should keep a certain distance from the LED power supply and other wires (5...10 cm is preferred).
- No secondary switches are allowed.
- Incorrect wiring can damage the LED.
- The wire must be well protected against short circuits.

Technical information

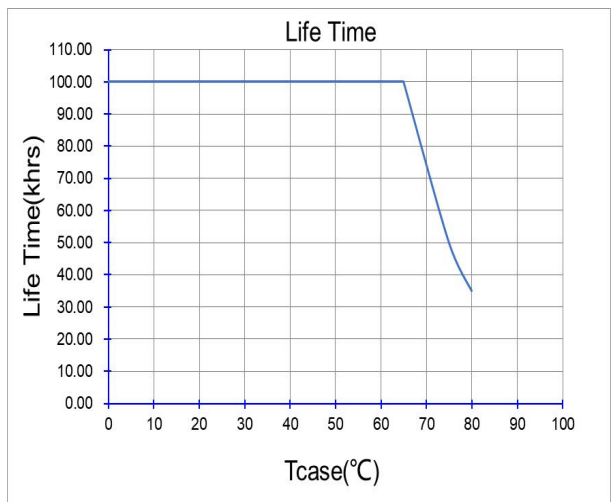
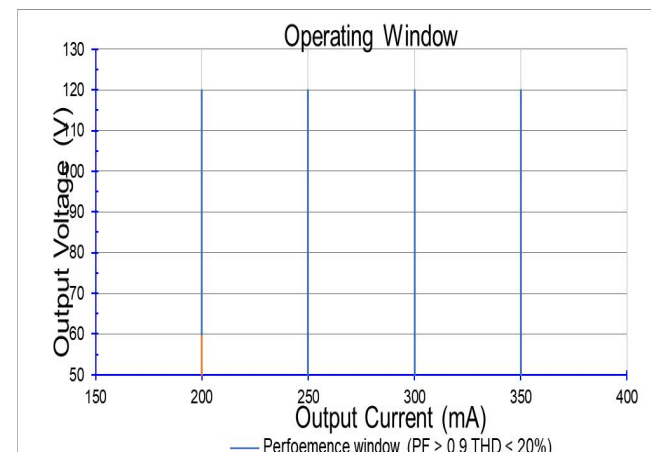
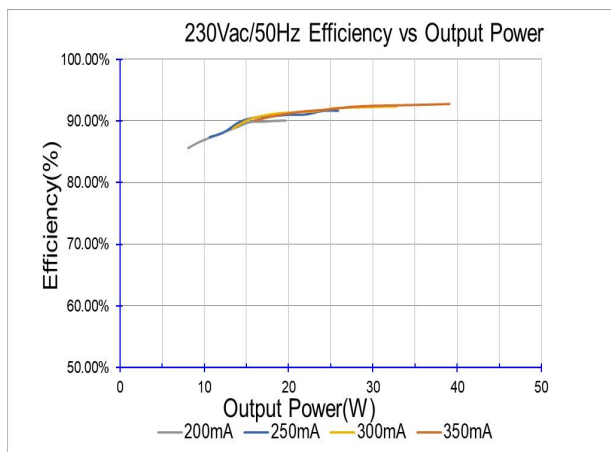
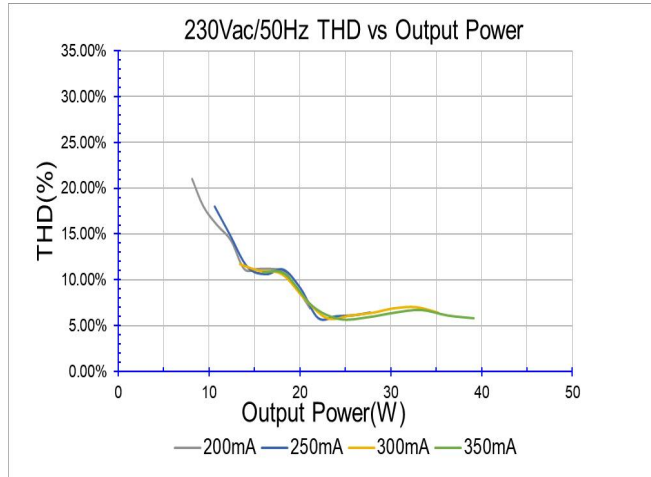
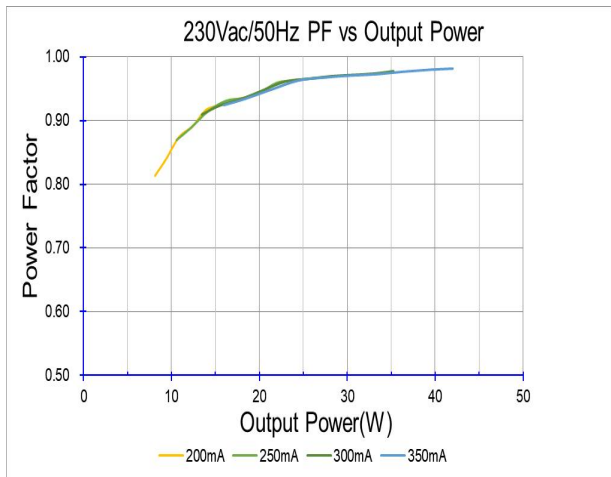

It's important to set the output current (AOC value) according to the LED voltage and make sure the power is within 42 W + 5%.

Adjustable output current with DIPSWITCH

Vout	Pout	Iout	1	2
52...120 Vdc	24 W	200 mA	OFF	OFF
52...120 Vdc	30 W	250 mA	OFF	ON
52...120 Vdc	36 W	300 mA	ON	OFF
52...120 Vdc	42 W	350 mA	ON	ON