

Product features



- Built-in isolated adjustable power LED driver
- Flicker-free LED driver
- Supports DALI-2 Push Dimming
- NFC control adjusts the current
- Output current 100...700 mA
- Max. output power 28 W
- Constant lumen output (CLO)
- DC emergency: Current output decreased to 15% (other values can be programmed)
- For luminaires with protection class I,II
- 5 years warranty



Product specifications

164189 ID ECSCI 28/230/100-700 DALI NFC

Output current	Input voltage	Output voltage	Efficiency @ full load	Current accuracy	Power factor	Dimension LxWxH (mm)
100...700 mA	220...240 Vac 220...240 Vdc	9...42 Vdc	90%	± 5%	0.9	205x31x42 TBD

Electrical specifications

Mains voltage supply

Rated input voltage range	220...240 Vac
Max. input voltage range	198...264 Vac
Rated frequency range	0/50/60 Hz
Max. input current	0.14 A @ 230 Vac

Battery operation

DC voltage range	220...240 Vdc
Max. DC voltage range	176...280 Vdc

Protection against voltage peaks

Withstand voltage	l/p-O/p 3.75 kVac, < 5 mA 60 sec
Mains surge immunity	L-N 1 kV

Total harmonic distortion (THD)

At rated input voltage range @ full load	10%
--	-----

Output data

Output current tolerance	± 5% at rated input voltage range
No load output voltage	55 Vdc
Ripple output current	5%
Output PstLM	≤ 1 at full load @ rated input voltage
Output SVM	≤ 0.4 at full load @ rated input voltage

Protection functions output side

Overvoltage protection	The output voltage is less than or equal to 55 V
Overpower protection	The output power is less than or equal to 28 W
Short circuit protection	Yes

Dimming operation and interface

Dimming range	1%...100%
Standby power consumption	0.3 W

Connection terminals

Connection terminal type	45° push in terminal
Wire cross section	Output wire: 0.5...1.5 mm ²
Wire stripping length	8...9 mm

Degree of protection

Protection rating	IP20
-------------------	------

Operating data

Output current range	NFC control adjusts the current: 100...700 mA
Default current	100 mA
Output voltage range	9...42 Vdc
Noise level	< 20 dB, at full load @ 100 cm distance

Circuit breaker / Inrush current

MCB loading quantity	Inrush current I _{peak} : TBD A			Inrush current T _{width} : TBD μs	
	MCB type	B10	C10	B16	C16
	Units	TBD	TBD	TBD	TBD

Supplementary instructions

- The luminaire manufacturer is responsible for measuring and verifying the EMI compliance of the complete luminaire, as the level of radio interference will vary depending on the luminaire construction. Especially primary and secondary cable lengths and their routing may have a significant effect on radio interference.
- For the push DIM function, please follow our instructions, which can be downloaded from www.cupower.com.
- Short circuit protection: Hiccup mode. Protection device will trigger when short circuit and will auto recover after the fault mode is removed

Environmental specifications

Operating temperature	-20...+35°C
Storage temperature	-25...+85°C
Working humidity	10%...90%
Store humidity	5%...95%
Lifetime	at Tc 85°C: 50,000 hrs; at Tc 75°C: 100,000 hrs; @ 230 Vac
Maximum Tc temperature	85°C

Safety & EMC compliance

ENEC+CE	CCC	SAA
EN 61347-1:2015/A1:2021		AS 61347.2.13:2018
EN 61347-2-13:2014/A1:2017		AS/NZS 61347.1:2016+A1
EN IEC 62384:2020		
EN 300 330 V2.1.1:2017		
EN 62479:2010		
EN 50663:2017		
EN 301 489-1 V2.2.3:2019		
EN 301 489-3 V2.1.1:2019		
EN IEC 55015:2019/A11:2020		
EN 61547:2009		
EN IEC 61000-3-2:2019/A1:2021		
EN 61000-3-3:2013/A2:2021		
EN 61347-1:2015/A1:2021		
EN 61347-2-13:2014/A1:2017		
EN 62493:2015		

Dimensions

Housing dimensions

Length (L)	205 mm
Width (W)	31 mm
Height (H)	42 mm
Weight	TBD kg

Packaging details

Packing units	TBD pcs
Carton size	TBD mm
Weight	TBD kg

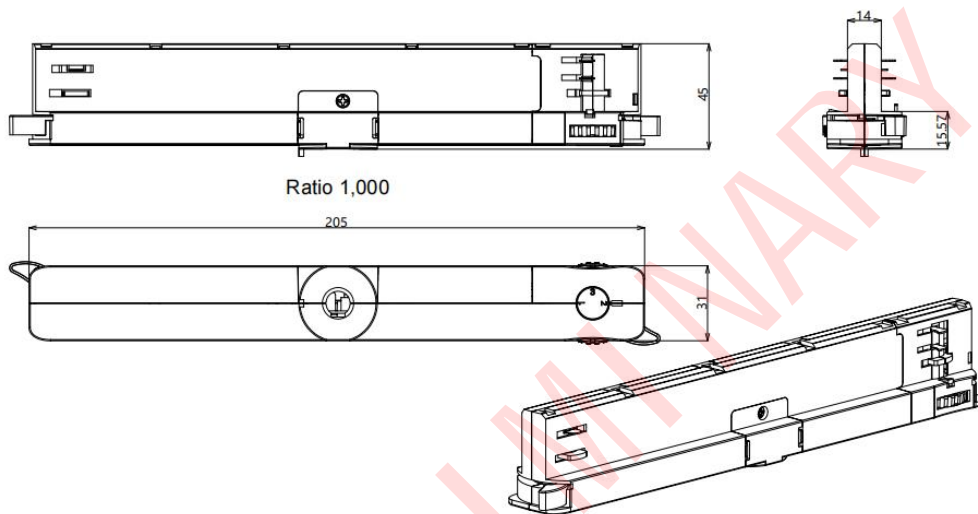

Wiring diagram

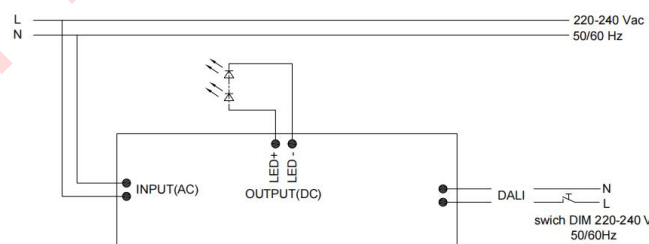

- All connections must be as short as possible to ensure good EMI performance.
- The luminaire wire should keep a certain distance from the LED power supply and other wires (5...10 cm is preferred).
- No secondary switches are allowed.
- Incorrect wiring can damage the LED.
- The wire must be well protected against short circuit.

Technical information

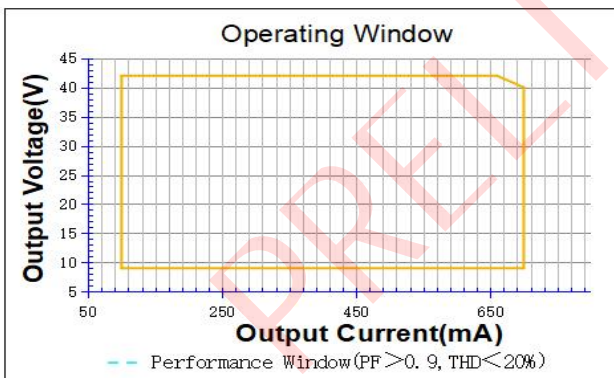
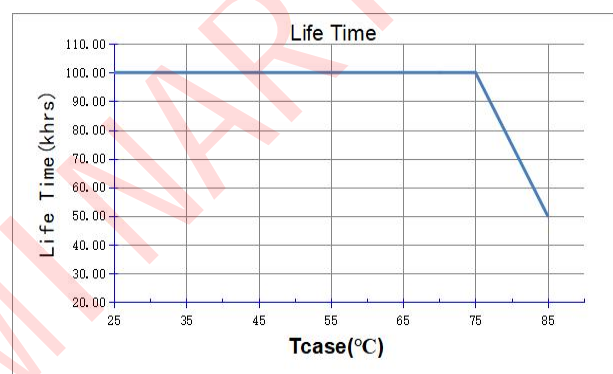
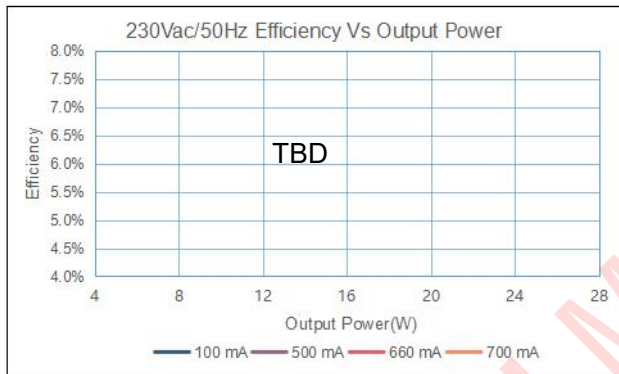
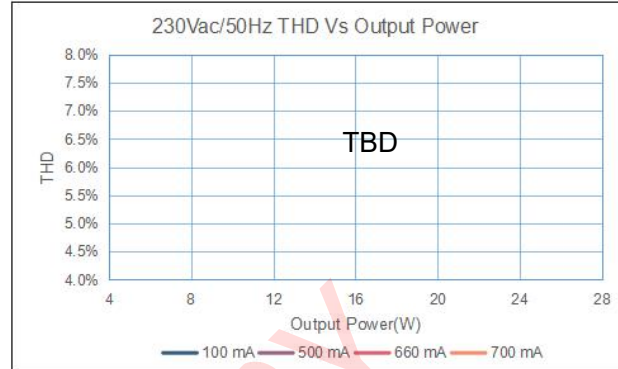
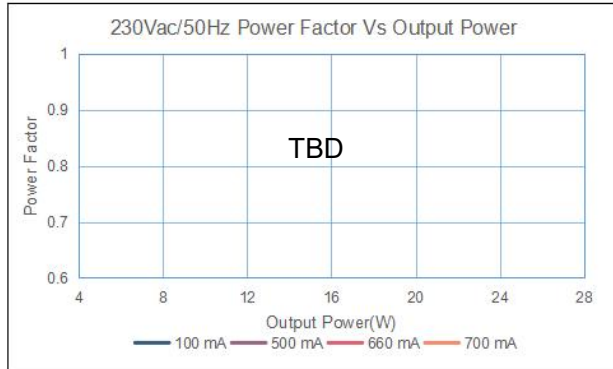

It's important to set the output current (AOC value) according to the LED voltage and make sure the power is within 28 W + 5%.

Example of AOC settings

V LED (Vdc)	AOC max	Pout (W)
40	700 mA	28
42	660 mA	28
42	500 mA	21
42	100 mA	4.2